

fischer 

**Dynamic
fixing solutions.**



Dynamic loads and their applications.

Dynamic loads are also called non-static loads, and are involved in particular in mechanical engineering, and more and more often in construction. There are assumed to be a very large number of load changes (switching between loading and unloading, changes in the loading direction or changes in the load height) over the service life of the component. These load changes occur at anchorages with

plugs, for instance on robots, cranes, and elevators. However, they also occur on trains passing by noise protection walls or trucks in road tunnels, which generate dynamic loads on installations due to the constant interchange between pressure and suction caused by airflow.

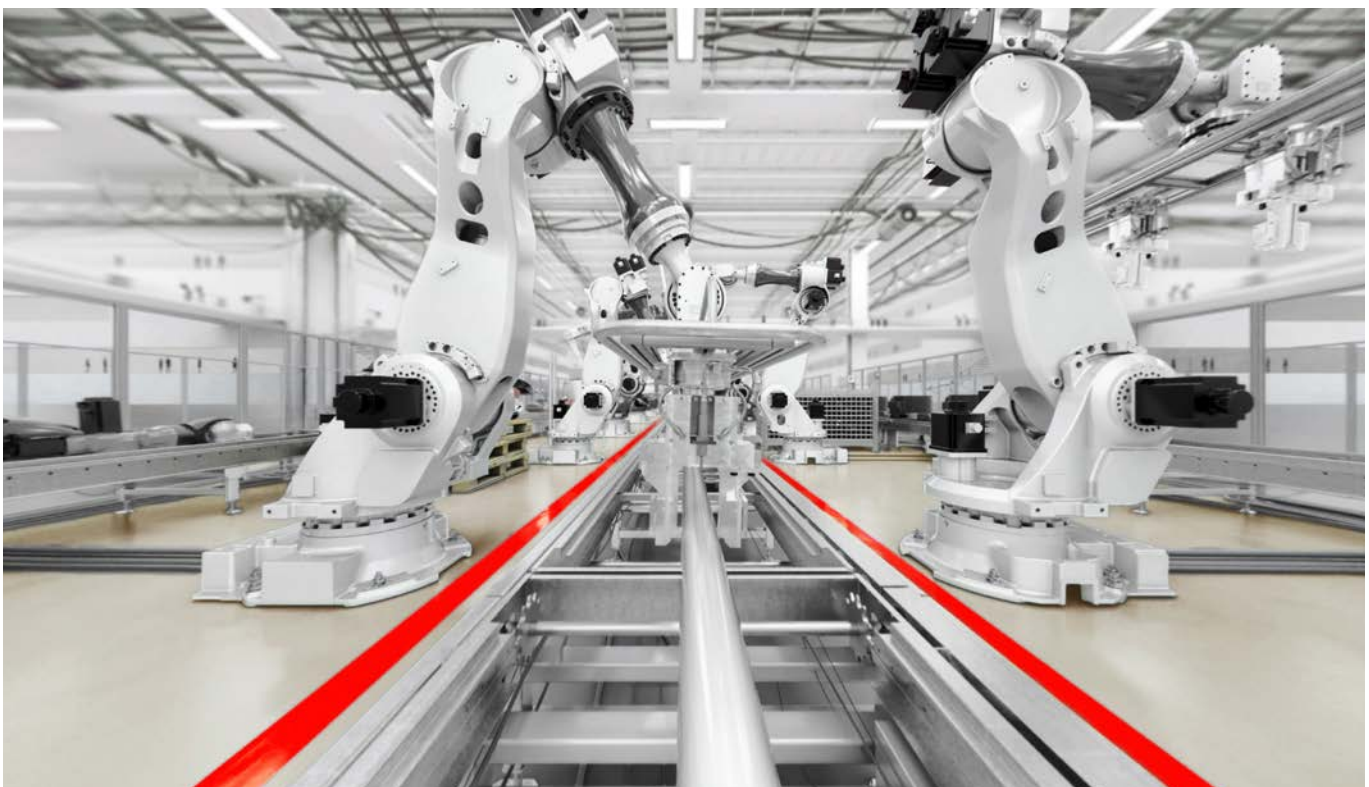

Types of loads: Repeated load cycle, alternating load, static load.

Repeated load cycles occur, for instance, due to the tilting moment of slewing pillar cranes, which move by rotating on their axes, depending on the crane position, with a suspended load between the "0" state (pressure, and therefore no load on the plugs) and the maximum tensile load value on the plugs. Alternating loads may act on a plug group used to fix a crane rail in the longitudinal direction, for instance, through braking and acceleration forces. Effects caused by earthquakes are not relevant to fatigue, and should therefore be considered separately. Wind loads are primarily considered static loads according to the Eurocode. While the load fluctuates between "0" and the positive maximum tensile load for a dynamic repeated load cycle on plug anchorages, the mathematical sign changes in case of a dynamic repeated load cycle, which describes an acting lateral load. The load relevant

for the calculation, therefore, is determined from the values for the positive and negative maximum, for example with a positive and negative extreme value of 5 as „ $-5\text{I} + 1+5\text{I} = 10\text{ kN}$ “.

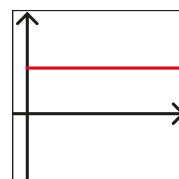

statically dormant

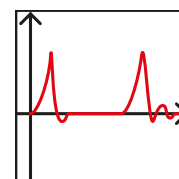

dynamically rising

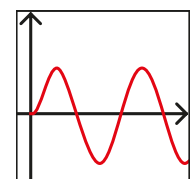

dynamically changing

Requirements for anchorages subject to dynamic loads:



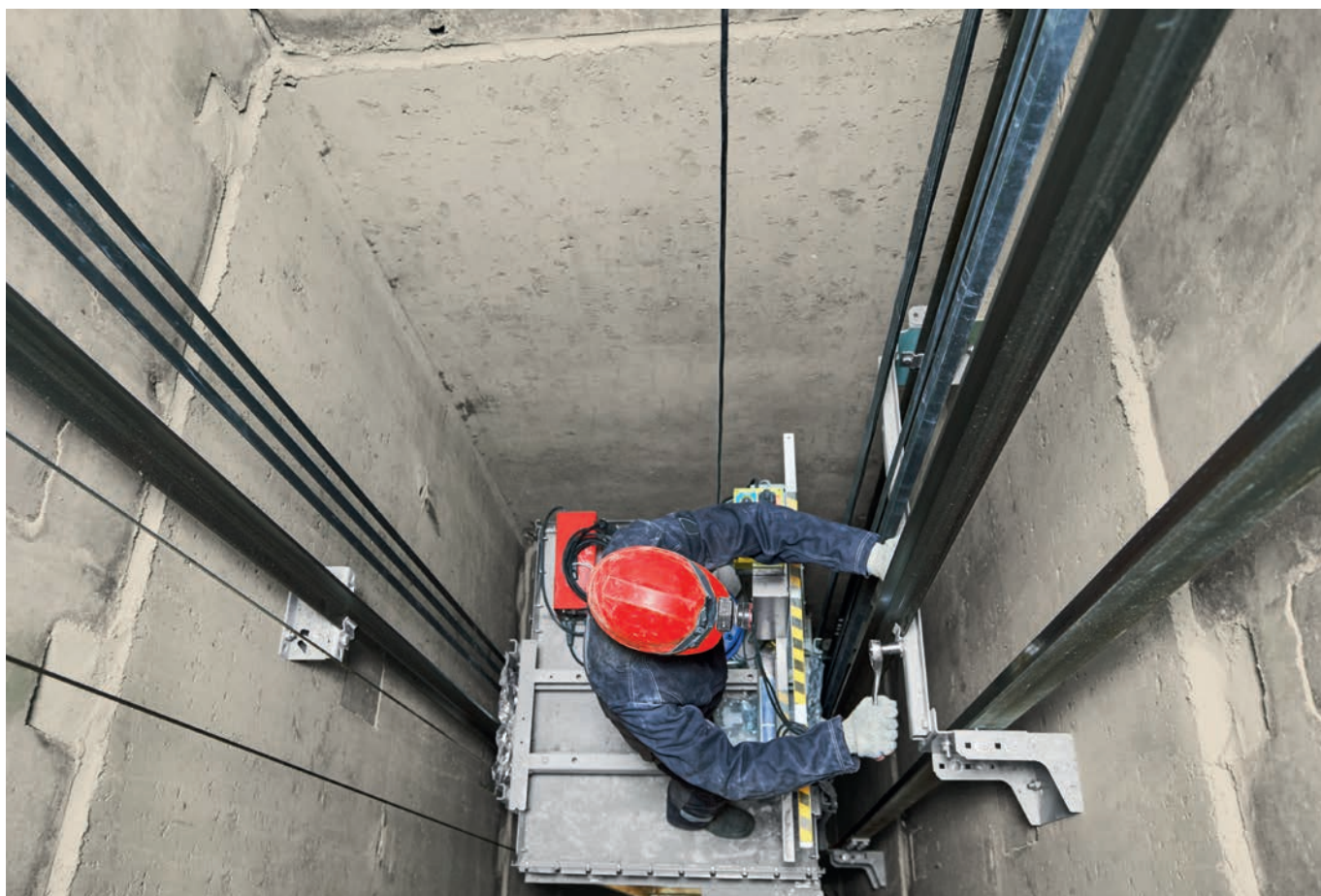

To anchor a component exposed to dynamic loads, plugs approved for primarily non-static load cases must be used in areas covered by construction law. However, this only makes sense if the overall structure is designed for dynamic loads. Currently, such approvals are issued in the form of general building approvals (AbZ), design certifications (Abg) or an European Technical Assessment (ETA), and only for the anchorage substrate concrete.

In contrast to primarily dormant loads, with dynamic lateral loads it is highly important that there is no annular gap between the steel components and plugs, in order to effectively prevent increasing deformation of the anchor due to the changing load. To ensure this, the annular gap between the wall of the borehole in the steel component and the plugs generally needs to be filled with high-strength injection mortar.

Powerful dynamic anchors have a spherical disc and bevelled washer to ensure maximum load-bearing capability under dynamic loads, instead of a normal washer. This allows them to optimally compensate for a minor tilt in the anchor due to installation. This allows for even load transfer and application, in particular under tensile loads. Use of a locking nut is also essential to prevent the load-bearing nut from coming loose accidentally due to vibration, or due to frequent load changes. Anchorages can be designed very economically and easily using the fischer C-FIX design software, which is part of the FiXperience program family.



Selection matrix for dynamic anchors.

The right dynamic fixing solution for every application				
				
Designation	Highbond dynamic anchors FHB dyn	Dynamic anchors FDA	Superbond dynamic anchor FSB dyn	Bolt anchor FAZ II Plus Dynamic
Pre-positioned installation	•	–	•	•
Push-through installation	•	•	•	•
Subsequent filling of annular gap with mortar	•	–	•	•
Locking nut	•	•	•	•
Load level	100%	80%	approx. 10 - 50%	approx. 10 - 50%
Assortment / Sizes	M12 - M24	M12 + M16	M12 - M24	M16 - M24
Lateral force optimized version	M12 + M16	–	–	–
Anchor plate thickness	8 - 150 mm	12 - 80 mm	12 - 200 mm	15 - 300 mm
Minimum concrete component thickness	130 mm	130 mm	100 mm	140 - 200mm
Zinc-plated for dry indoor areas	M12 - M24	M12 + M16	M12 + M16	M16 - M24
Stainless steel - CRC III: Moist areas, outdoor areas	–	–	M12 - M24	M16 - M24
Stainless steel 1.4529 - CRC V: e.g. Road tunnels	M12 + M16	–	–	–
Capsule system	–	–	•	–
Mortar system in cartridge	•	•	•	for annular gap filling mortar required
Diamond drill bit	acc. approval for M12 and M16	–	•	–
Drill hole cleaning hollow drilling	no further drill hole cleaning required	no further drill hole cleaning required	no further drill hole cleaning required	no further drill hole cleaning required
Drill hole cleaning hammer drilling injection system	2x blow-out, 2x brush, 2x blow-out	2x blow-out, 2x brush, 2x blow-out	2x blow-out, 2x brush, 2x blow-out	–
Drill hole cleaning hammer drilling capsule system	–	–	4x blow-out	–
Curing time at 20°C (Mortar / Capsule)	35 min. / -	35 min. / -	30 min. / 20 min.	Anchors can be loaded immediately
Series installation	++	++	++	+++
Ceiling installation	+	+	++	+++
Anchor pre-installed	–	•	–	–

Applications

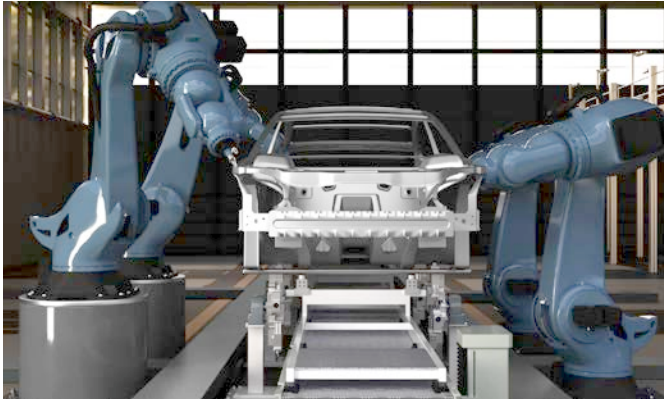

Robot fixing



Elevator assemblies



Crane fixing

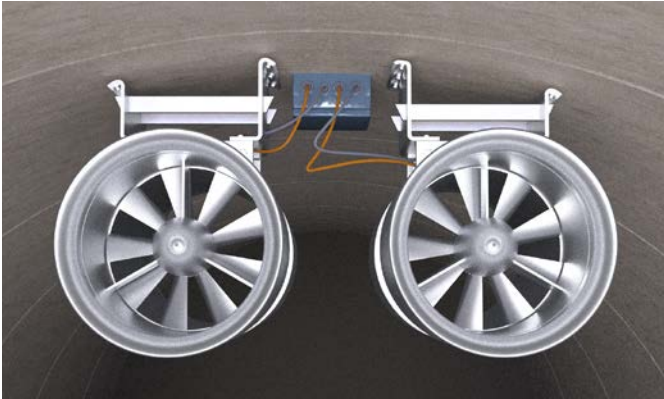

Ceiling fans



Noise protection walls



Pumps

Highbond-Anchor dynamic FHB dyn. The performance class amongst anchors.



FIS HB 360 S
Highbond special mortar.



FHB-A dyn
Highbond anchor
dynamic.



FHB-A dyn V
Highbond-anchor dynamic
optimised for lateral forces.

Your advantages at a glance

- High tensile loads thanks to the conical geometry of the threaded rod.
- High shear loads thanks to an additional sleeve on the version optimized for lateral force FHB-A dyn V.
- Version in zinc-plated steel for indoor areas, as well as in highly corrosion-resistant steel 1.4529 for applications outdoors, in moist areas and in atmospheres with a high level of chlorine.
- Easy push-through installation and pre-positioned installation.
- Thanks to the drill hole in the filler disc, the annular gap can be filled subsequently with pre-positioned installation.
- Large assortment in sizes M12 - M24.
- You can use the C-FIX design software to take advantage of the power offered by fischer Highbond dynamic anchors, and complete measurements with individual framework conditions.

Installation, functioning and test marks.

Pre-positioned installation FHB dyn

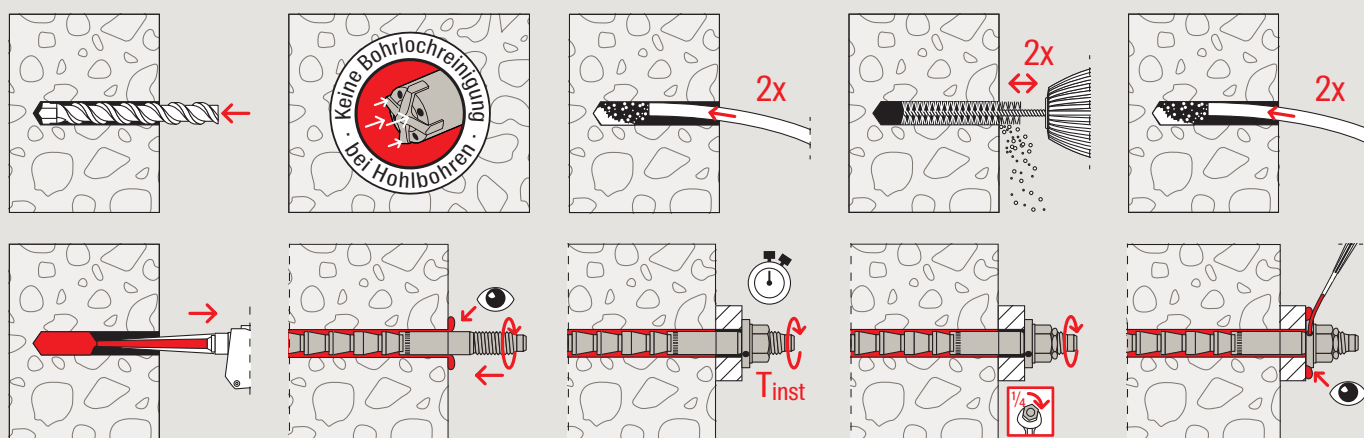

Push-through installation FHB dyn

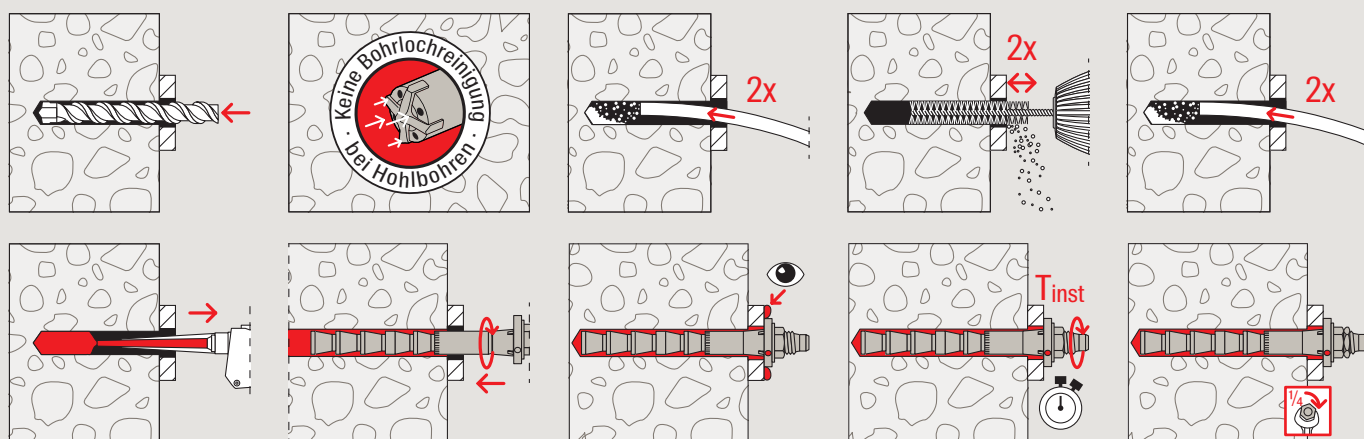

Function

- The injection system suitable for tensile zones consists of the Highbond dynamic anchor rod FHB-A dyn and the injection mortar FIS HB.
- Extruding the mortar causes the two components to be mixed and activated in the static mixer. The conical threaded rod is inserted manually into the drill hole filled with injection mortar FIS HB and turned back and forth slightly. The mortar pushes past the threaded rod and bonds it completely to the drill hole wall.

Approval



Assortment

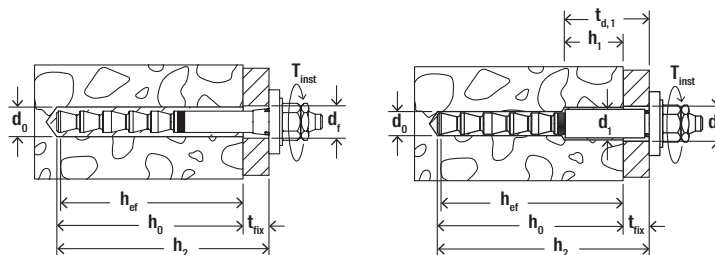

Highbond-Anchor dynamic FHB-A dyn and Highbond anchor dynamic FHB-A dyn V



FHB-A dyn

FHB-A dyn V

Item	Zinc-plated steel	Highly corrosion resistant steel	Approval	Drill hole diameter	Drill hole diameter in fixture	Anchorage depth	Min. - max. usable length	Min. drill hole depth for through fixings	Width across nut	Sales unit
	Item No. gvz	Item No. HCR	DIBt	d_0 [mm]	d_1 [Ø mm]	h_{ef} [mm]	t_{in} [mm]	h_2 [mm]	SW [mm]	[pcs]
FHB-A dyn 12 x 100/25	092018	531384 ¹⁾	●	14	15	100	8 - 25	130	19	10
FHB-A dyn 12 x 100/25	—	561726	●	14	15	100	8 - 25	130	19	4
FHB-A dyn 12 x 100/50	092019	—	●	14	15	100	8 - 50	155	19	10
FHB-A dyn 16 x 125/25	092020	—	●	18	19	125	10 - 25	155	24	10
FHB-A dyn 16 x 125/50	092036	093445 ¹⁾	●	18	19	125	10 - 50	180	24	10
FHB-A dyn 16 x 125/50	—	561727 ¹⁾	●	18	19	125	10 - 50	180	24	4
FHB-A dyn 16 x 125/75	562302	—	●	18	19	125	10 - 75	205	24	10
FHB-A dyn 16 x 125/80	541874	—	●	18	19	125	10 - 80	210	24	10
FHB-A dyn 16 x 125/100	541875	—	●	18	19	125	10 - 100	230	24	10
FHB-A dyn 16 x 125/125	541873	—	●	18	19	125	10 - 125	255	24	10
FHB-A dyn 16 x 125/150	543657	—	●	18	19	125	10 - 150	280	24	10
FHB-A dyn 20 x 170/50	092037	—	●	24	25	170	12 - 50	225	30	10
FHB-A dyn 24 x 220/50	092038	—	●	28	29	220	14 - 50	275	36	5
FHB-A dyn 12 x 100/50 V	092039 ²⁾	—	●	14	21	105	8 - 50	160	19	10
FHB-A dyn 16 x 125/50 V	092040 ³⁾	—	●	18	29	130	10 - 50	185	24	10

¹⁾ Prices and delivery time on request.

²⁾ Stepped hole: 1st drill hole with Ø 20 mm and depth 85 mm. 2nd drill hole with Ø 14 mm and depth 160 mm.

³⁾ Stepped hole: 1st drill hole with Ø 28 mm and depth 100 mm. 2nd drill hole with Ø 18 mm and depth 185 mm.

Injection mortar FIS HB



FIS HB 150 C

FIS HB 360 S

FIS MR Plus

Item	Item No.	Approval	Languages on the cartridge	Contents	Sales unit [pcs]
		ETA			
FIS HB 150 C	519665	●	DE, FR, NL	1 cartridge 145 ml, 2 x FIS MR Plus	6
FIS HB 360 S	562659	●	DE, FR, IT, NL	1 cartridge 360 ml, 2 x FIS MR Plus	6
FIS HB 360 S	562658	●	EN, ZH	1 cartridge 360 ml, 2 x FIS MR Plus	6
FIS HB 360 S	562660	●	EN, PL, RU, CS, SK	1 cartridge 360 ml, 2 x FIS MR Plus	6
FIS HB 360 S	562661	●	EN, ES, PT, EL	1 cartridge 360 ml, 2 x FIS MR Plus	6
FIS HB 360 S	568247	●	DN, SV, NO, FI	1 cartridge 360 ml, 2 x FIS MR Plus	6
FIS HB 360 S	569207	●	EN, TR	1 cartridge 360 ml, 2 x FIS MR Plus	6
FIS HB 360 S	519125	●	DE	1 cartridge 360 ml, 2 x FIS MR Plus	6
FIS MR Plus	545853	—	—	10 static mixer FIS MR Plus	10

Installation data

Curing times

FIS HB System temperature FIS HB (Mortar min. +5 °C) [°C]	Maximum processing time FIS HB t_{work} [min.]	Minimum curing time FIS HB ¹⁾ t_{cure} [min.]
-5 – -1	–	360
0 – +4	–	180
> +5 – +9	15	90
> +10 – +19	6	35
> +20 – +29	4	20
> +30 – +40	2	12

¹⁾ In wet concrete the curing times must be doubled.

Filling quantities

FHB dyn Type	Mortar volume in scale units shown on the cartridge labels' corresponding scala	Anchor per cartridge FIS HB 360 S ^{*)}
FHB-A dyn 12 x 100 / 25	7	24
FHB-A dyn 12 x 100 / 50	8	21
FHB-A dyn 16 x 125 / 25	9	18
FHB-A dyn 16 x 125 / 50	10	17
FHB-A dyn 16 x 125 / 75	11	15
FHB-A dyn 16 x 125 / 80	11	15
FHB-A dyn 16 x 125 / 100	12	14
FHB-A dyn 16 x 125 / 125	13	12
FHB-A dyn 16 x 125 / 150	14	12
FHB-A dyn 20 x 170 / 50	23	7
FHB-A dyn 24 x 220 / 50	38	4
FHB-A dyn 12 x 100 / 50 V	12	14
FHB-A dyn 16 x 125 / 50 V	20	8

^{*)} Max. number with one static mixer.

Dynamic-Anchor FDA.

The push-through anchor for series installation with medium loads.

Your advantages at a glance

- Medium load level for a variety of applications.
- Pre-assembled anchor rod for fast installation.
- Simple push-through installation ensures a high level of economic efficiency, especially in series installations.
- Streamlined assortment in sizes M12 and M16 in zinc-plated steel.
- You can use the C-FIX design software to take advantage of the power offered by fischer dynamic anchor rods, and complete design with individual framework conditions.



FIS HB 360 S
Highbond special mortar



FDA-A
Dynamic anchor.

Installation, functioning and test marks.

Push-through installation FDA

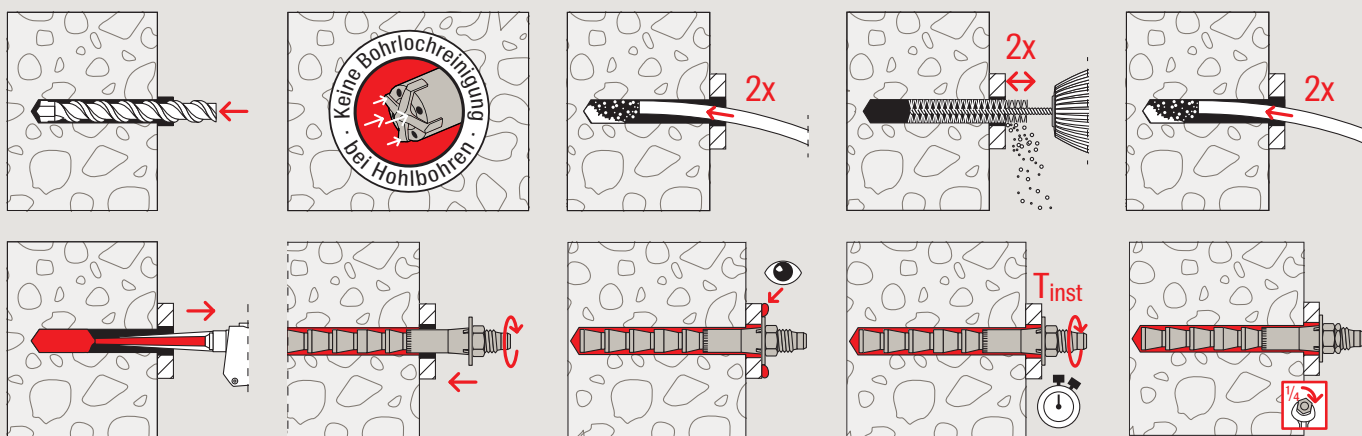

Function

- The injection system suitable for tensile zones consists of the fischer dynamic anchor rod FDA-A and the injection mortar FIS HB.
- Extruding the mortar causes the two components to be mixed and activated in the static mixer. The conical anchor rod is inserted manually into the drill hole filled with injection mortar FIS HB and turned back and forth slightly. The mortar pushes past the anchor rod and bonds it completely to the drill hole wall.

Approval



Assortment

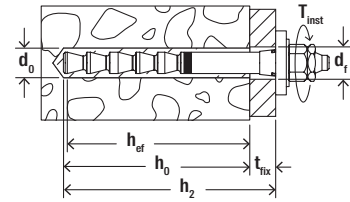

Dynamic anchor FDA



FDA

Item	Item No. gvz	Approval	Drill hole diameter	Drill hole diameter in fixture	Anchorage depth	Min. - max. usable length	Min. drill hole depth for through fixings	Width across nut	Sales unit [pcs]
		ETA	d_0 [mm]	d_1 [Ø mm]	h_{ef} [mm]	t_{fix} [mm]	h_2 [mm]	SW [mm]	
FDA-A 12 x 100/25 gvz	536943	●	14	15	100	12 - 25	130	19	10
FDA-A 12 x 100/50 gvz	536944	●	14	15	100	12 - 50	155	19	10
FDA-A 16 x 125/25 gvz	536945	●	18	19	125	16 - 25	155	24	10
FDA-A 16 x 125/50 gvz	536946	●	18	19	125	16 - 50	180	24	10
FDA-A 16 x 125/80 gvz	558966	●	18	19	125	16 - 80	210	24	10

Injection mortar FIS HB



FIS HB 150 C



FIS HB 360 S



FIS MR Plus

Item	Item No.	Approval ETA	Languages on the cartridge	Contents	Sales unit [pcs]
FIS HB 150 C	519665	●	DE, FR, NL	1 cartridge 145 ml, 2 x FIS MR Plus	6
FIS HB 360 S	562659	●	DE, FR, IT, NL	1 cartridge 360 ml, 2 x FIS MR Plus	6
FIS HB 360 S	562658	●	EN, ZH	1 cartridge 360 ml, 2 x FIS MR Plus	6
FIS HB 360 S	562660	●	EN, PL, RU, CS, SK	1 cartridge 360 ml, 2 x FIS MR Plus	6
FIS HB 360 S	562661	●	EN, ES, PT, EL	1 cartridge 360 ml, 2 x FIS MR Plus	6
FIS HB 360 S	568247	●	DN, SV, NO, FI	1 cartridge 360 ml, 2 x FIS MR Plus	6
FIS HB 360 S	569207	●	EN, TR	1 cartridge 360 ml, 2 x FIS MR Plus	6
FIS HB 360 S	519125	●	DE	1 cartridge 360 ml, 2 x FIS MR Plus	6
FIS MR Plus	545853	—	—	10 static mixer FIS MR Plus	10

Installation data

Curing times

FIS HB System temperature FIS HB (Mortar min. +5 °C) [°C]	Maximum processing time FIS HB t_{work} [min.]	Minimum curing time FIS HB ¹⁾ t_{cure} [min.]
-5 – -1	–	360
0 – +4	–	180
> +5 – +9	15	90
> +10 – +19	6	35
> +20 – +29	4	20
> +30 – +40	2	12

¹⁾ In wet concrete the curing times must be doubled.

Filling quantities

FHB dyn Type	Mortar volume in scale units shown on the cartridge labels' corresponding scale	Anchor per cartridge FIS HB 360 S ^{*)}
FDA-A 12 x 100 / 25	7	24
FDA-A 12 x 100 / 50	8	21
FDA-A 16 x 125 / 25	9	18
FDA-A 16 x 125 / 50	10	17
FDA-A 16 x 125 / 80	11	15

^{*)} Max. number with one static mixer.

Superbond dynamic FSB dyn. Fixing with FIS A and RG M for dynamic loads.

Your advantages at a glance

- For the first time, the system offers values for load-bearing capacity under dynamic load in an ETA for fischer threaded rods FIS A and RG M in the strength class 8.8 zinc-plated and stainless steel R-70. Using the filling set. The ETA requires zinc-plated steel in sizes M12 and M16, and stainless steel R in sizes M12 to M24.
- FIS A threaded rods are mounted with FIS SB injection mortar and RGM threaded rods must be mounted with RSB mortar capsules or FIS SB injection mortar.
- The version with RG M threaded rods and RSB capsules is ideal for accessories kits or applications with diamond drill holes.
- Approved threaded rods in stainless steel R can be used outdoors.
- Variable anchorage depth allows for ideal adaptation to the load, and ensures an optimised installation time and use of materials.
- Low component thickness as well as centre and edge distances.



FIS SB 390 S
Superbond Injection mortar.



FIS A
With dynamic filling
set for push-through
assembly.



RSB
Capsules.

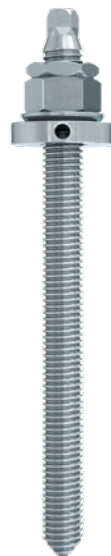

RG M
With dynamic filling
set for push-through
assembly.

Installation with threaded rod FIS A.

Pre-positioned installation FIS A with filling set

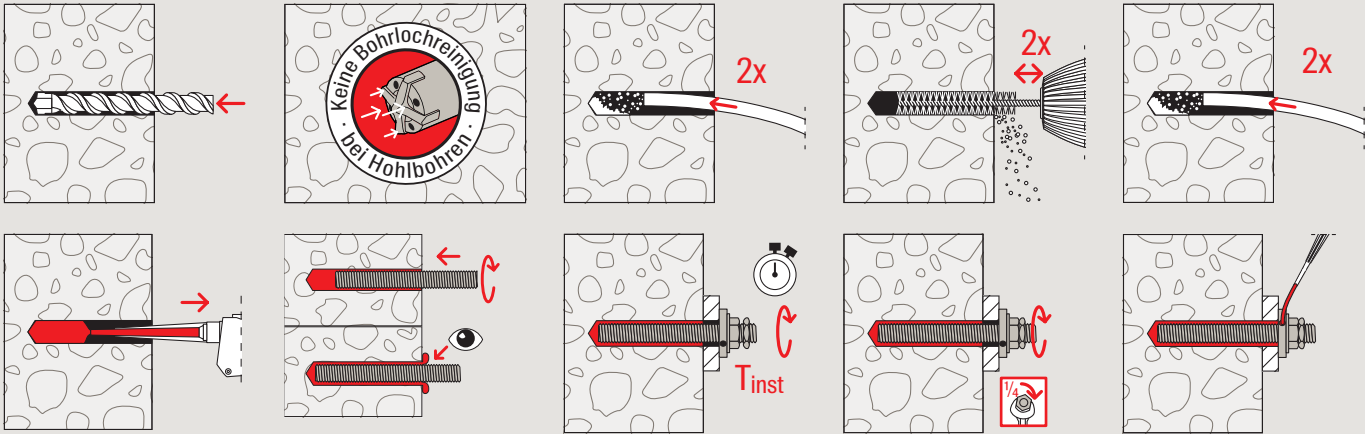

Push-through installation FIS A with filling set ¹⁾

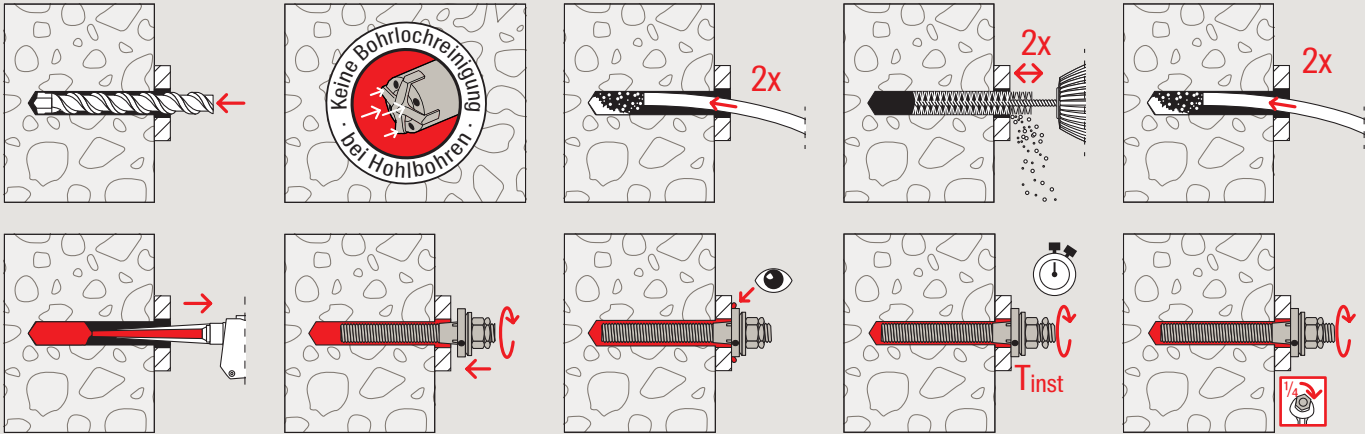

¹⁾ Push-through installation for M20 + M24 possible even without the filling disc.

Installation with resin capsules RSB and RG M.

Pre-positioned installation RG M with filling set

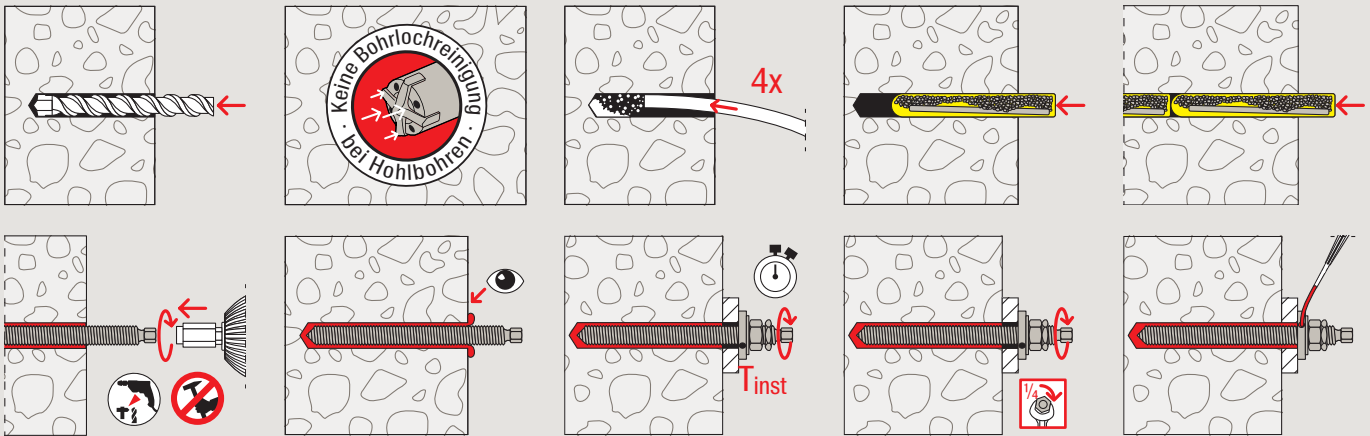

Push-through installation RG M with filling set

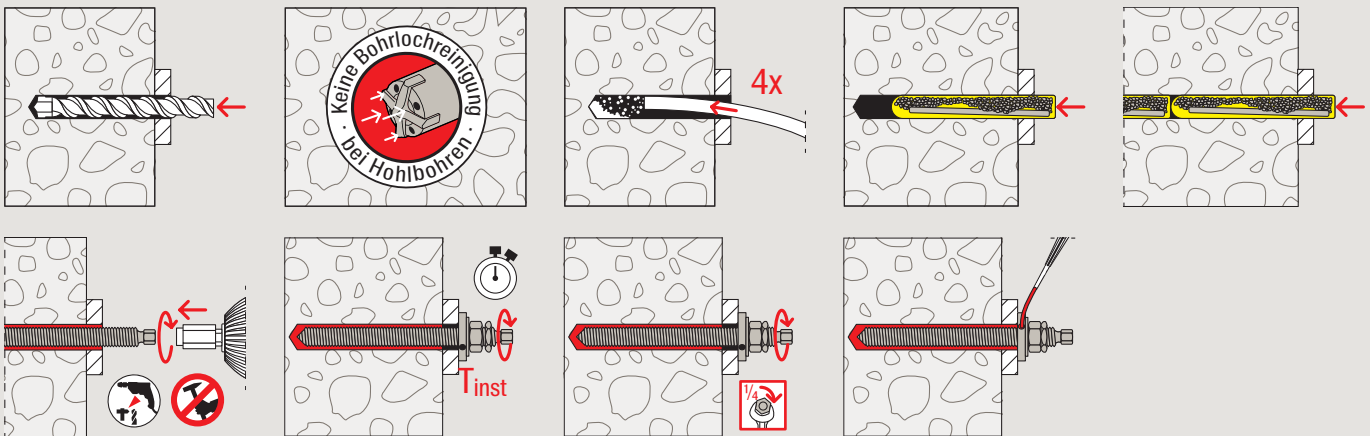

Installation, functioning and test marks.

Pre-positioned installation RG M with capsule RSB (diamond drilling)

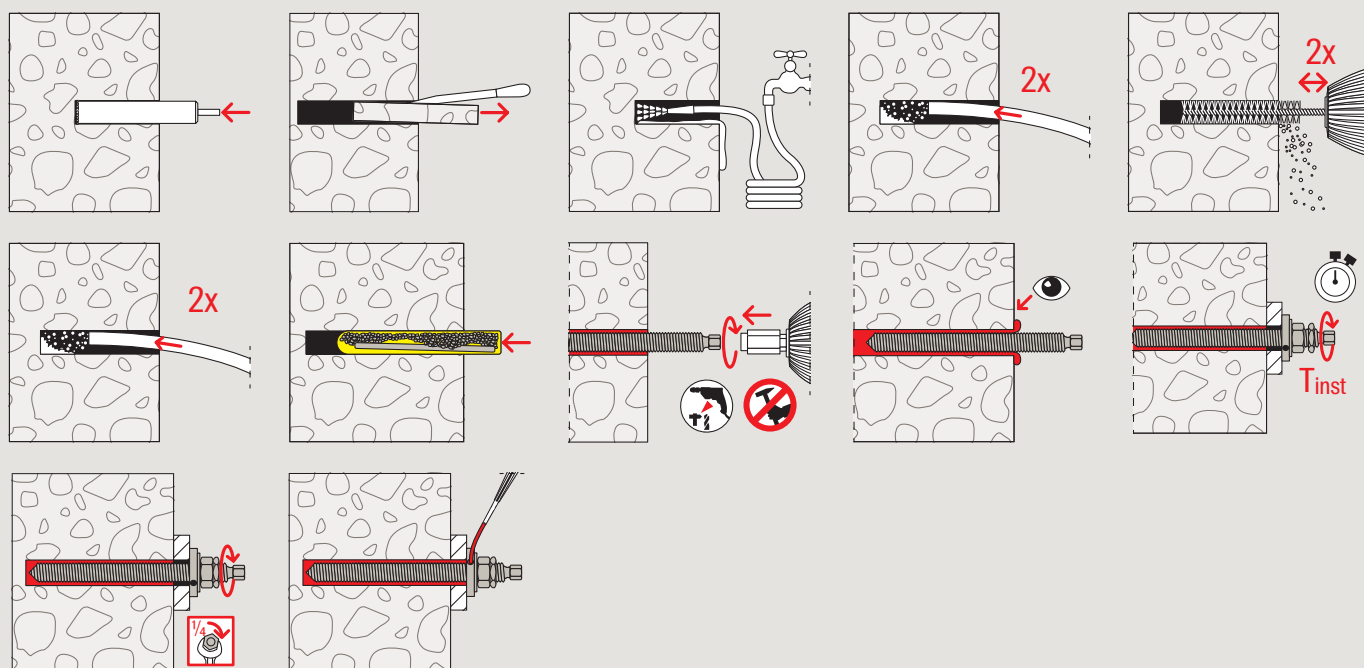

Function

- Threaded rod FIS A in combination with FIS SB injection mortar is approved for pre-positioned and push-through installation.
- Threaded rod RG M in combination with the RSB resin capsule is approved for pre-positioned and push-through installation.
- The injection system ensures a full-surface connection between the fixing element and wall of the drill hole, and seals the drill hole.
- The centring sleeve centres the threaded rod in push-through installation in the fixture, thus ensuring a safe load application.
- The lock nut prevents the hexagonal nut from becoming loose.
- The filling disc ensures that the annular gap between the threaded rod and steel attachment is filled seamlessly in pre-positioned installation, thereby ensuring reliable load transmission.

Approval



Assortment

Superbond dynamic FSB dyn



FIS SB 390 S

FIS MR Plus

Item	Item No.	Approval ETA	Languages on the cartridge	Scale unit	Contents	Sales unit [pcs]
FIS SB 390 S	519451	●	DE, FR, NL	180	1 cartridge 390 ml, 2 x FIS MR Plus	6
FIS SB 390 S	520557	●	DE, SL, SR, BG	180	1 cartridge 390 ml, 2 x FIS MR Plus	6
FIS SB 390 S	518831	●	EN, ES, PT	180	1 cartridge 390 ml, 2 x FIS MR Plus	6
FIS SB 390 S	519450	●	IT, DE, EN	180	1 cartridge 390 ml, 2 x FIS MR Plus	6
FIS SB 390 S	520559	●	DA, SV, NO, FI	180	1 cartridge 390 ml, 2 x FIS MR Plus	6
FIS SB 390 S	520555	●	CS, SK, RO	180	1 cartridge 390 ml, 2 x FIS MR Plus	6
FIS SB 390 S	520595	●	PL, RU, HU	180	1 cartridge 390 ml, 2 x FIS MR Plus	6
FIS SB 585 S	562065	●	FR, NL, DE	270	1 cartridge 585 ml + 2 x FIS UMR	6
FIS SB 585 S	519452	●	EN, ES, PT	270	1 cartridge 585 ml + 2 x FIS UMR	6
FIS SB 585 S	520526	●	IT, DE, EN	270	1 cartridge 585 ml + 2 x FIS UMR	6
FIS SB HIGH SPEED 390 S	523303	●	PL, RU, HU	180	1 cartridge 390 ml, 2 x FIS MR Plus	6
FIS MR Plus	545853	—	—	—	10 static mixer FIS MR Plus	10
FIS UMR	520593	—	—	—	10 static mixer for 585 ml	10

Superbond dynamic FSB dyn



FIS SB 390 S HWK big

FIS SB 390 S in bucket

Item	Item No.	Approval ETA	Languages on the cartridge	Contents	Sales unit [pcs]
FIS SB 390 S HWK big	540252	●	EN, ES, PT	20 cartridges 390 ml, 40 x FIS MR Plus	1
FIS SB 390 S HWK big	520573	●	IT, DE, EN	20 cartridges 390 ml, 40 x FIS MR Plus	1
FIS SB 390 S in bucket	540750	●	EN, ES, PT	18 cartridges 390 ml, 36 x FIS MR Plus	1

Assortment and installation data

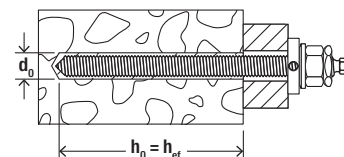

Resin capsule RSB

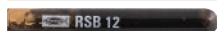

RSB

Item	Item No.	Approval ETA	Drill diameter	Drill hole depth	Anchorage depth	Suitable for threaded rod	Sales unit [pcs]
			d_0 [mm]	h_0 [mm]	h_{ef} [mm]		
RSB 12 mini	518822 ¹⁾	●	14	75 / 150	75 / 150	RG M 12	10
RSB 12	518823	●	14	110	110	RG M 12	10
RSB 16 mini	518824 ¹⁾	●	18	95 / 190	95 / 190	RG M 16	10
RSB 16	518825	●	18	125	125	RG M 16	10
RSB 20	518827	●	25	170	170	RG M 20	10
RSB 20 E/24	518828	●	25/28/32	210	210	RG M 20 / RG M 22	5

¹⁾ use 2 x RSB mini in a row for larger anchoring depth.

Curing times

FSB dyn Temperature in anchoring base [°C]	Maximum processing time FIS SB	Maximum processing time FIS SB High Speed	Minimum curing time FIS SB		Minimum curing time FIS SB High Speed		Minimum curing time RSB	
	t_{work} [Min.]	t_{work} [Min.]	t_{cure} [hrs.]	[min.]	t_{cure} [hrs.]	[min.]	t_{cure} [hrs.]	[min.]
-30 – -20	–	–	–	–	–	–	120	–
>-20 – -15	–	60	–	–	24	–	48	–
>-15 – -10	60	30	36	–	8	–	30	–
>-10 – -5	30	15	24	–	3	–	16	–
>-5 – 0	20	10	8	–	2	–	10	–
>0 – +5	13	5	4	–	1	–	–	45
>+5 – +10	9	3	2	–	–	45	–	30
>+10 – +20	5	2	1	–	–	30	–	20
>+20 – +30	4	1	–	45	–	15	–	5
>+30 – +40	2	–	–	30	–	–	–	3

Assortment

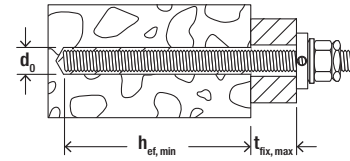

Threaded rod FIS A



FIS A

Item	Zinc plated, steel grade 8.8	Stainless steel	Approval	Drill hole diameter	Min. / max. anchorage depth	Min. / max. usable length	Min. / max. filling quantity	Sales unit
	Item No. gvz	Item No. R	ETA	d_0 [mm]	[mm]	[mm]	[scale units]	[pcs]
FIS A M 12 x 120	519397	044974	●	14	70 / 83	12 / 25	3 / 4	10
FIS A M 12 x 140	519398	090450	●	14	70 / 103	12 / 45	3 / 5	10
FIS A M 12 x 160	517937	090451	●	14	70 / 123	12 / 65	3 / 6	10
FIS A M 12 x 180	519399	090452	●	14	70 / 143	12 / 85	3 / 6	10
FIS A M 12 x 200	517938	—	●	14	70 / 163	12 / 105	3 / 7	10
FIS A M 12 x 210	—	090453	●	14	70 / 173	12 / 115	3 / 8	10
FIS A M 12 x 260	—	090454	●	14	70 / 223	12 / 165	3 / 10	10
FIS A M 12 x 280	—	547703	●	14	70 / 243	12 / 85	3 / 10	10
FIS A M 16 x 130	519400	044975	●	18	80 / 84	16 / 20	5 / 5	10
FIS A M 16 x 175	519401	090455	●	18	80 / 129	16 / 65	5 / 8	10
FIS A M 16 x 200	517939	090456	●	18	80 / 154	16 / 90	5 / 9	10
FIS A M 16 x 250	517940	090457	●	18	80 / 204	16 / 140	5 / 12	10
FIS A M 16 x 300	—	090458	●	18	80 / 254	16 / 190	5 / 15	10
FIS A M 20 x 245	—	090459	●	24	90 / 189	20 / 119	11 / 23	10
FIS A M 20 x 290	—	090460	●	24	90 / 234	20 / 164	11 / 29	10
FIS A M 24 x 290	—	090461	●	28	96 / 223	24 / 151	14 / 32	5
FIS A M 24 x 380	—	090462	●	28	96 / 313	24 / 200	14 / 45	5

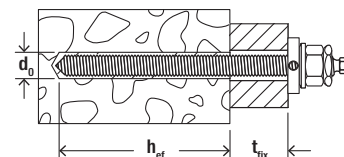

Threaded rod RG M



RG M

Item	Stainless steel	Approval ETA	Drill hole diameter	Anchorage depth	Usable length	Fits capsule RSB	Sales unit [pcs]
	Item No. R		d_0 [mm]	h_{ef} [mm]	t_{fx} [mm]		
RG M 12 x 120	535011	●	14	75	12-13	1 x RSB 12 mini	10
RG M 12 x 160	050265	●	14	75 / 110	12-53 / 12-18	1 x RSB 12 mini 1 x RSB 12	10
RG M 12 x 180	512249	●	14	75 / 110	12-73 / 12-38	1 x RSB 12 mini 1 x RSB 12 2 x RSB 12 mini	10
RG M 12 x 200	050576	●	14	75 / 110	12-93 / 12-58	1 x RSB 12 mini 1 x RSB 12 2 x RSB 12 mini	10
RG M 12 x 220	050297	●	14	75 / 110 / 150	12-113 / 12-78 / 12-38	1 x RSB 12 mini 1 x RSB 12 2 x RSB 12 mini	10
RG M 12 x 250	095702	●	14	75 / 110 / 150	12-143 / 12-108 / 12-68	1 x RSB 12 mini 1 x RSB 12 2 x RSB 12 mini	10
RG M 12 x 300	095705	●	14	75 / 110 / 150	12-193 / 12-158 / 12-118	1 x RSB 12 mini 1 x RSB 12 2 x RSB 12 mini	10
RG M 12 x 380	095710 ¹⁾	●	14	75 / 110 / 150	12-200 / 12-200 / 12-198	1 x RSB 12 mini 1 x RSB 12 2 x RSB 12 mini	10
RG M 16 x 165	095704	●	18	95	16-32	1 x RSB 16 mini 1 x RSB 16	10
RG M 16 x 190	050266	●	18	95 / 125	16-57 / 16-27	1 x RSB 16 mini 1 x RSB 16	10
RG M 16 x 250	050298	●	18	95 / 125 / 190	16-117 / 16-87 / 16-22	1 x RSB 16 mini 1 x RSB 16 2 x RSB 16 mini	10
RG M 16 x 300	050299	●	18	95 / 125 / 190	16-167 / 16-137 / 16-72	1 x RSB 16 mini 1 x RSB 16 2 x RSB 16 mini	10
RG M 16 x 380	095712 ¹⁾	●	18	95 / 125 / 190	16-200 / 16-200 / 16-152	1 x RSB 16 mini 1 x RSB 16 2 x RSB 16 mini	10
RG M 16 x 500	095713 ¹⁾	●	18	95 / 125 / 190	16-200 / 16-200 / 16-200	1 x RSB 16 mini 1 x RSB 16 2 x RSB 16 mini	10
RG M 20 x 260	050267	●	25	170	20-47	1 x RSB 20 1 x RSB 20 E / 24	10
RG M 20 x 350	095706	●	25	170 / 210	20-137 / 20-97	1 x RSB 20 1 x RSB 20 E / 24	10
RG M 24 x 300	050268 ¹⁾	●	28	210	24-47	1 x RSB 20 E / 24	10
RG M 24 x 400	095715 ¹⁾	●	28	210	24-147	1 x RSB 20 E / 24	10

¹⁾ Straight cut, additional setting tool required.

- max. usable length at dynamic application 200 mm.

- Information about anchorage depth and usable length refer to the installation with filling disc. While using standard washers for the sizes M20 + M24 other values are valid.

Accessories

Filling set

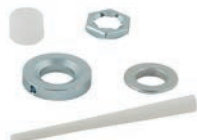

Filling set for subsequent filling of the annular gap



Filling set Push-through assembly

Item	Item No.	Content	External diameter [mm]	Internal diameter [mm]	Height [mm]	Attachment thickness ≥ [mm]
Filling set M12 gvz.	537218	10x bag, content per bag: 1x centring bush, 1x fillable bevel washer, 1x rounded washer, 1x locking nut, 1x Injection nozzle	30	14	9	12
Filling sets M16 gvz.	537219	10x bag, content per bag: 1x centring bush, 1x fillable bevel washer, 1x rounded washer, 1x locking nut, 1x Injection nozzle	38	19	11	16
Filling sets M12 R	557875	10x bag, content per bag: 1x centring bush, 1x fillable bevel washer R, 1x rounded washer R, 1x locking nut R, 1x Injection nozzle	30	14,2	9	12
Filling sets M16 R	557876	10x bag, content per bag: 1x centring bush, 1x fillable bevel washer R, 1x rounded washer R, 1x locking nut R, 1x Injection nozzle	40	19,2	11	16
Filling sets M20 R	557877	10x bag, content per bag: 1x centring bush, 1x fillable bevel washer R, 1x rounded washer R, 1x locking nut R, 1x Injection nozzle	50	23,2	13	20
Filling sets M24 R	557878	10x bag, content per bag: 1x centring bush, 1x fillable bevel washer R, 1x rounded washer R, 1x locking nut R, 1x Injection nozzle	55	28	17	24
Filling sets M20 R push-through	557879	10x bag, content per bag: 1x locking nut R, 1x centring bush	37	21	–	20
Filling sets M24 R push-through	557880	10x bag, content per bag: 1x locking nut R, 1x centring bush	44	25	–	24

Pre-assembly with FIS A and injection system FIS SB
Sizes: M12, M16, M20, M24

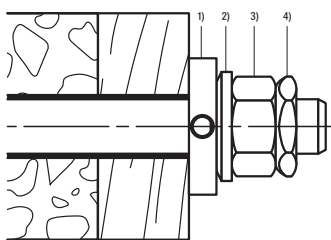

Push-through installation with FIS A and injection system FIS SB
Sizes: M12, M16, M20, M24

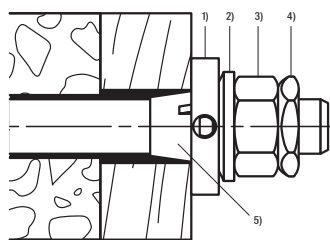

Push-through installation with FIS A and injection system FIS SB
Sizes: M20, M24

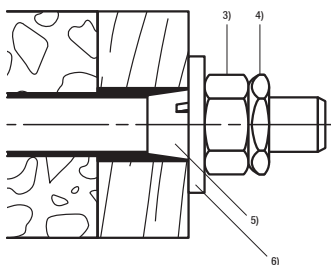

Pre-assembly / Push-through installation with RG M and cartridge system RSB
Sizes: M12, M16, M20, M24

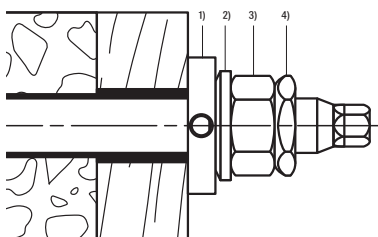

- ¹⁾ filling disc for subsequent backfilling of the annular gap
- ²⁾ cone ladle
- ³⁾ hex nut
(Included in the delivery of the anchor rod)
- ⁴⁾ locking nut
- ⁵⁾ centring sleeve
- ⁶⁾ washer
(Included in the delivery of the anchor rod)

FAZ II Plus.

The power anchor for dynamic applications.

Quick and easy installation for higher efficiency as a perfect alternative to injection systems for dynamic stress.

The new ETA confirms the use of the FAZ II Plus for dynamic loads for diameters M16-M24.

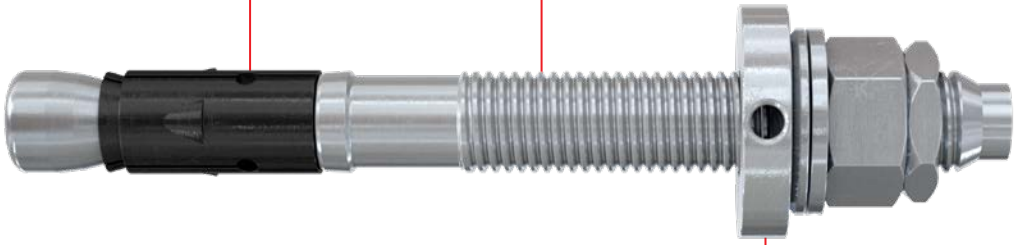

Dynamic Set for safe installation.

Your advantages at a glance

- The new ETA confirms the use of the FAZ II Plus for dynamic loads for diameters M16-M24 (galvanised steel or stainless steel).
- The fast installation process of the FAZ II Plus provides an efficient fixing solution for dynamic applications with low load cycles with an immediately loadable fixing point.
- Easy and safe installation with Dynamic Set.

Functioning

- The FAZ II is suitable for pre-positioned and push-through installation.
- For dynamic loads, an additional „dynamic set“ is used, which is filled with injection mortar (compressive strength $\geq 50\text{N/mm}^2$ e.g.: FIS V, FIS EM Plus, FIS HB or FIS SB) after installation.

Approvals



Mounting with Dynamic Set

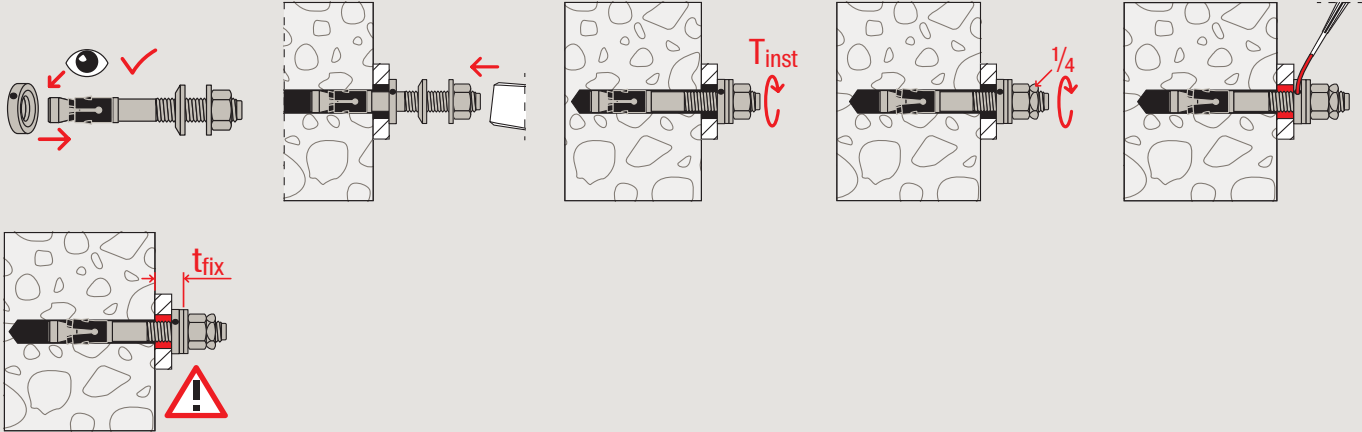

Assortment

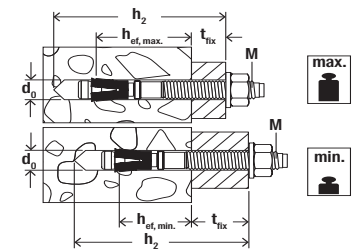

Bolt anchor FAZ II Plus (Standard version)



Bolt anchor FAZ II Plus

Item	Art.-No.		Approval	Drill diameter	Min. drill hole depth for push-through installation	Anchor length	Standard embedment depth with respective usable length ²⁾		Min. anchoring depth with related working length		Thread	Sales unit	
	Steel, zincplated	Stainless steel					$h_{ef,stand.}$ [mm]	$t_{fix}^{3)}$ [mm]	$h_{ef,min}$ [mm]	$t_{fix}^{3)}$ [mm]			Ø x length [mm]
	gvz	R											
FAZ II Plus 16/25	564595	564627	●	16	133	148	85	25	65	45	M 16 x 84	10	
FAZ II Plus 16/50	564596	—	●	16	158	173	85	50	65	70	M 16 x 109	10	
FAZ II Plus 16/50	—	564628	●	16	158	173	85	50	65	70	M 16 x 109	20	
FAZ II Plus 16/60	—	564629	●	16	168	183	85	60	65	80	M 16 x 119	20	
FAZ II Plus 16/100	564597	564630	●	16	208	223	85	100	65	120	M 16 x 159	10	
FAZ II Plus 16/160	564598	—	●	16	268	283	85	160	65	180	M 16 x 189	10	
FAZ II Plus 16/200	564599	—	●	16	308	323	85	200	65	220	M 16 x 189	10	
FAZ II Plus 16/250	564600	—	●	16	358	373	85	250	65	270	M 16 x 100	10	
FAZ II Plus 16/300	564601	—	●	16	408	423	85	300	65	320	M 16 x 100	10	
FAZ II Plus 20/60	564603	—	●	20	190	202	100	60	—	—	M 20 x 84	5	
FAZ II Plus 20/60	—	564632	●	20	190	202	100	60	—	—	M 20 x 84	4	
FAZ II Plus 20/160	564604	—	●	20	290	302	100	160	—	—	M 20 x 100	5	
FAZ II Plus 24/60	564606	—	●	24	219	235	125	60	—	—	M 24 x 88	5	
FAZ II Plus 24/60	—	564634	●	24	219	235	125	60	—	—	M 24 x 88	4	

¹⁾ Only with maximum embedment depth

²⁾ Maximum anchorage depth see ETA

³⁾ The thickness of the dynamic set must be subtracted from the working length t_{fix} . M16 = 11 mm, M20 = 13 mm and M24 = 17 mm.

Accessories



Bolt anchor-Setting tool FA-ST II

Bolt anchor-Setting tool FA-ST II set

Item	Art.-No.	Inner-Ø [mm]	Outer-Ø [mm]	Contents [pcm]	Match	Sales unit [pcs]
FA-ST II M16	558792	-	-	SDS adapter; socket SW 24	FAZ II Plus M16	1
FA-ST II Set	558789	-	-	SDS adapter; je 1x socket SW 17, SW 19, SW 24	FAZ II Plus M10/M12/M16	1

Dynamic Set



Dynamic Set

Item	Art.-No.	Outer-Ø [mm]	Thickness dynamic set [mm]	Min. fixture thickness t_{fix} [mm]	Match	Sales unit [pcs]
Dynamic Set M16	568785	38	11	15	FAZ II Plus M16	10
Dynamic Set M20	568786	46	13	20	FAZ II Plus M20	10
Dynamic Set M24	568787	54	17	24	FAZ II Plus M24	10
Dynamic Set M16 R	568788	40	11	15	FAZ II Plus M16 R	10
Dynamic Set M20 R	568789	50	13	20	FAZ II Plus M20 R	10
Dynamic Set M24 R	568790	55	17	24	FAZ II Plus M24 R	10

Loads

Highbond anchor dynamic FHB dyn

Design values for cyclic fatigue loading¹⁾ of a single anchor normal concrete of strength class C20/25²⁾.
For the design the complete current approval Z-21.3-1748 has to be considered.

Type	Material/surface	Effective anchorage depth h_{ef} [mm]	Minimum member thickness h_{min} [mm]	Installation torque T_{inst} [Nm]	Cracked and non-cracked concrete			
					Design values of tension ($\Delta N_{Ed,max}$) and shear loads ($\Delta V_{Ed,max}$); minimum spacing (s_{min}) and edge distances (c_{min}) with reduced loads			
					$\Delta N_{Ed,max}$ ³⁾ [kN]	$\Delta V_{Ed,max}$ ³⁾⁴⁾ [kN]	s_{min} ⁴⁾ [mm]	c_{min} ⁴⁾ [mm]
FHB dyn 12 x 100	gvz	100	130	40	14.1	6.7	100	200 ⁵⁾
	gvz	100	200	40	14.1	6.7	100	100 ⁵⁾
	HCR / 1.4529	100	130	40	11.3	4.4	100	200 ⁵⁾
	HCR / 1.4529	100	200	40	11.3	4.4	100	100 ⁵⁾
FHB dyn 12 x 100 V	gvz	105	130	40	14.1	9.6	100	200 ⁵⁾
	gvz	105	200	40	14.1	9.6	100	100
FHB dyn 16 x 125	gvz	125	160	60	23.0	11.9	100	200 ⁵⁾
	gvz	125	250	60	23.0	11.9	100	100
	HCR / 1.4529	125	160	60	15.6	11.9	100	200 ⁵⁾
	HCR / 1.4529	125	250	60	15.6	11.9	100	100 ⁵⁾
FHB dyn 16 x 125 V	gvz	130	160	60	23.0	17.0	100	200 ⁵⁾
	gvz	130	250	60	23.0	17.0	100	100
FHB dyn 20 x 170	gvz	170	220	100	28.4	17.0	80	80
FHB dyn 24 x 220	gvz	220	440	120	28.9	22.2	180	180 ⁵⁾

¹⁾ The design values of the cyclic fatigue loading apply for load cycles $\geq 5 \times 10^6$ in accordance with design method I - for unknown static lower load. If the static lower load is known and / or for lower number of load cycles higher load values are possible. The partial safety factors as regulated in the design standard are considered. As a single anchor counts e.g. an anchor with a spacing $s \geq 3 \times h_{ef}$. The given load values apply for anchorages in dry and wet concrete and temperatures in the base material up to 50 °C (resp. short-term up to 80 °C) and drill hole cleaning acc. to approval.

²⁾ For higher concrete strength classes up to C50/60 higher permissible loads may be possible, see approval. The concrete is assumed to be standard-reinforced.

³⁾ In the case of combinations of tensile loads, shear loads, bending moments with reduced or minimum spacing and edge distances (anchor groups) the design must be carried out in accordance with the provisions of the complete approval.

⁴⁾ Valid for pulsating loads. For alternating loads see approval.

⁵⁾ Without reduction of the tension and shear load. For details see approval.

Dynamic-Anchor FDA

Design values for cyclic fatigue loading¹⁾ of a single anchor normal concrete of strength class C20/25²⁾.
For the design the complete current assessment ETA-20/0206 has to be considered.

Type	Material fixing element	Effective anchorage depth h_{ef} [mm]	Minimum member thickness h_{min} [mm]	Installation torque T_{inst} [Nm]	Cracked and non-cracked concrete			
					Design values of tension ($\Delta N_{Ed,max}$) and shear loads ($\Delta V_{Ed,max}$); minimum spacing (s_{min}) and edge distances (c_{min}) with reduced loads			
					$\Delta N_{Ed,max}$ ³⁾ [kN]	$\Delta V_{Ed,max}$ ³⁾⁴⁾ [kN]	s_{min} ⁴⁾ [mm]	c_{min} ⁴⁾ [mm]
FDA 12 x 100	gvz	100	130	40	10.8	5.0	100	200 ⁵⁾
	gvz	100	200	40	10.8	5.0	100	100 ⁵⁾
FDA 16 x 125	gvz	125	160	60	18.5	9.1	100	200 ⁵⁾
	gvz	125	250	60	18.5	9.1	100	100

¹⁾ The design values of the cyclic fatigue loading apply for load cycles $\geq 5 \times 10^6$ in accordance with design method I acc. to TR061 - for unknown static lower load. If the static lower load is known and / or for lower number of load cycles higher load values are possible. The partial safety factors as regulated in the design standard are considered. As a single anchor counts e.g. an anchor with a spacing $s \geq 3 \times h_{ef}$. The given load values apply for anchorages in dry and wet concrete and temperatures in the base material up to 50 °C (resp. short-term up to 80 °C) and drill hole cleaning acc. to assessment.

²⁾ For higher concrete strength classes up to C50/60 higher permissible loads may be possible, see assessment. The concrete is assumed to be standard-reinforced.

³⁾ In the case of combinations of tension loads, shear loads, bending moments with reduced or minimum spacing and edge distances (anchor groups) the design must be carried out in accordance with the provisions of the complete assessment.

⁴⁾ Valid for pulsating loads. For alternating loads see assessment.

⁵⁾ Without reduction of the tension and shear load. Details see assessment.

Superbond dynamic with Superbond mortar FIS SB and threaded rod FIS A resp. RG M

Design values for cyclic fatigue loading¹⁾ of a single anchor normal concrete of strength class C20/25²⁾.
For the design the complete current assessment ETA-19/0501 has to be considered.

Type	Material/ surface	Effective anchorage depth h_{ef} [mm]	Minimum member thickness h_{min} [mm]	Installation torque T_{inst} [Nm]	Cracked concrete				Non-cracked concrete			
					Design values of tension ($\Delta N_{Ed,max}$) and shear loads ($\Delta V_{Ed,max}$); minimum spacing (s_{min}) and edge distances (c_{min}) with reduced loads				Design values of tension ($\Delta N_{Ed,max}$) and shear loads ($\Delta V_{Ed,max}$); minimum spacing (s_{min}) and edge distances (c_{min}) with reduced loads			
					$\Delta N_{Ed,max}^{3)}$ [kN]	$\Delta V_{Ed,max}^{3)}$ [kN]	$s_{min}^{3)}$ [mm]	$c_{min}^{3)}$ [mm]	$\Delta N_{Ed,max}^{3)}$ [kN]	$\Delta V_{Ed,max}^{3)}$ [kN]	$s_{min}^{3)}$ [mm]	$c_{min}^{3)}$ [mm]
FIS A M 12	8.8	70	100	40	3.0	2.0	55	55	4.5	2.0	55	55
	8.8	110	140	40	4.5	2.0	55	55	4.5	2.0	55	55
	8.8	240	270	40	4.5	2.0	55	55	4.5	2.0	55	55
	R-70	70	100	40	3.0	2.7	55	55	4.8	2.7	55	55
	R-70	110	140	40	4.9	2.7	55	55	4.9	2.7	55	55
	R-70	240	270	40	4.9	2.7	55	55	4.9	2.7	55	55
FIS A M 16	8.8	80	120	60	4.8	3.7	65	65	8.4	3.7	65	65
	8.8	125	170	60	8.4	3.7	65	65	8.4	3.7	65	65
	8.8	320	360	60	8.4	3.7	65	65	8.4	3.7	65	65
	R-70	80	120	60	4.8	4.9	65	65	8.4	4.9	65	65
	R-70	125	170	60	8.8	4.9	65	65	9.2	4.9	65	65
	R-70	320	360	60	9.2	4.9	65	65	9.2	4.9	65	65
FIS A M 20	R-70	90	140	120	7.1	7.6	85	85	12.4	7.6	85	85
	R-70	170	220	120	14.3	7.6	85	85	14.3	7.6	85	85
	R-70	400	450	120	14.3	7.6	85	85	14.3	7.6	85	85
FIS A M 24	R-70	96	160	150	7.4	11.0	105	105	11.8	11.0	105	105
	R-70	210	270	150	20.2	11.0	105	105	20.6	11.0	105	105
	R-70	480	540	150	20.6	11.0	105	105	20.6	11.0	105	105

¹⁾ The design values of the cyclic fatigue loading apply for load cycles $> 10^6$ in accordance with design method I acc. to TR061 - for unknown static lower load. If the static lower load is known and / or for lower number of load cycles higher load values are possible. The partial safety factors as regulated in the design standard are considered. As a single anchor counts e.g. an anchor with a spacing $s \geq 3 \times h_{ef}$. The given load values apply for anchorages in dry and wet concrete and temperatures in the base material up to 50 °C (resp. short-term up to 80 °C) and drill hole cleaning acc. to assessment.

²⁾ For higher concrete strength classes up to C50/60 higher permissible loads may be possible, see assessment. The concrete is assumed to be standard-reinforced.

³⁾ In the case of combinations of tension loads, shear loads, bending moments with reduced or minimum spacing and edge distances (anchor groups) the design must be carried out in accordance with the provisions of the complete assessment.

Loads

Superbond dynamic with Superbond capsule RSB and threaded rod RG M

Design values for cyclic fatigue loading¹⁾ of a single anchor normal concrete of strength class C20/25²⁾.
For the design the complete current assessment ETA-19/0501 has to be considered.

Type	Material/ surface	Effective anchorage depth h_{ef} [mm]	Minimum member thickness h_{min} [mm]	Installation torque T_{inst} [Nm]	Cracked concrete				Non-cracked concrete			
					Design values of tension ($\Delta N_{Ed,max}$) and shear loads ($\Delta V_{Ed,max}$); minimum spacing (s_{min}) and edge distances (c_{min}) with reduced loads				Design values of tension ($\Delta N_{Ed,max}$) and shear loads ($\Delta V_{Ed,max}$); minimum spacing (s_{min}) and edge distances (c_{min}) with reduced loads			
					$\Delta N_{Ed,max}$ ³⁾ [kN]	$\Delta V_{Ed,max}$ ³⁾ [kN]	s_{min} ³⁾ [mm]	c_{min} ³⁾ [mm]	$\Delta N_{Ed,max}$ ³⁾ [kN]	$\Delta V_{Ed,max}$ ³⁾ [kN]	s_{min} ³⁾ [mm]	c_{min} ³⁾ [mm]
RG M 12	8.8	75	110	40	3.3	2.0	55	55	4.5	2.0	55	55
	8.8	110	140	40	4.5	2.0	55	55	4.5	2.0	55	55
	8.8	150	180	40	4.5	2.0	55	55	4.5	2.0	55	55
	R-70	75	110	40	3.3	2.7	55	55	4.9	2.7	55	55
	R-70	110	140	40	4.9	2.7	55	55	4.9	2.7	55	55
	R-70	150	180	40	4.9	2.7	55	55	4.9	2.7	55	55
RG M 16	8.8	95	140	60	6.2	3.7	65	65	8.4	3.7	65	65
	8.8	125	170	60	8.4	3.7	65	65	8.4	3.7	65	65
	8.8	190	230	60	8.4	3.7	65	65	8.4	3.7	65	65
	R-70	95	140	60	6.2	4.9	65	65	9.2	4.9	65	65
	R-70	125	170	60	8.8	4.9	65	65	9.2	4.9	65	65
	R-70	190	230	60	9.2	4.9	65	65	9.2	4.9	65	65
RG M 20	R-70	170	220	120	14.3	7.6	85	85	14.3	7.6	85	85
	R-70	210	260	120	14.3	7.6	85	85	14.3	7.6	85	85
RG M 24	R-70	210	270	150	20.2	11.0	105	105	20.6	11.0	105	105

¹⁾ The design values of the cyclic fatigue loading apply for load cycles $> 10^6$ in accordance with design method I acc. to TR061 - for unknown static lower load. If the static lower load is known and / or for lower number of load cycles higher load values are possible. The partial safety factors as regulated in the design standard are considered. As a single anchor counts e.g. an anchor with a spacing $s \geq 3 \times h_{ef}$. The given load values apply for anchorages in dry and wet concrete and temperatures in the base material up to 50 °C (resp. short-term up to 80 °C) and drill hole cleaning acc. to assessment.

²⁾ For higher concrete strength classes up to C50/60 higher permissible loads may be possible, see assessment. The concrete is assumed to be standard-reinforced.

³⁾ In the case of combinations of tension loads, shear loads, bending moments with reduced or minimum spacing and edge distances (anchor groups) the design must be carried out in accordance with the provisions of the complete assessment.

Bolt anchor FAZ II Plus dynamic

Design values for cyclic fatigue loading¹⁾ of a single anchor in cracked or non-cracked normal concrete of strength class C20/25²⁾.
For the design the complete current assessment ETA-20/0897 of 20.12.2022 has to be considered.

Type	Material/ surface	Effective ancho- rage depth h_{ef} [mm]	Mini- mum member thick- ness h_{min} [mm]	Instal- lation torque T_{int} [Nm]	Cracked concrete				Non-cracked concrete			
					Design values of tension ($\Delta N_{Ed,max}$) and shear loads ($\Delta V_{Ed,max}$); minimum spacing (s_{min}) and edge distances (c_{min}) with reduced loads				Design values of tension ($\Delta N_{Ed,max}$) and shear loads ($\Delta V_{Ed,max}$); minimum spacing (s_{min}) and edge distances (c_{min}) with reduced loads			
					$\Delta N_{Ed,max}$ ³⁾ [kN]	$\Delta V_{Ed,max}$ ³⁾ [kN]	s_{min} ³⁾ [mm]	c_{min} ³⁾ [mm]	$\Delta N_{Ed,max}$ ³⁾ [kN]	$\Delta V_{Ed,max}$ ³⁾ [kN]	s_{min} ³⁾ [mm]	c_{min} ³⁾ [mm]
FAZ II Plus 16	gvz	65	140	110	6.0	4.7	65	65	6.4	4.7	65	65
	gvz	85	140	110	6.4	4.7	65	65	6.4	4.7	65	65
	gvz	160	240	110	6.4	4.7	65	65	6.4	4.7	65	65
	R-70	65	140	110	3.1	6.0	65	65	3.1	6.0	65	65
	R-70	85	140	110	3.1	6.0	65	65	3.1	6.0	65	65
	R-70	160	240	110	3.1	6.0	65	65	3.1	6.0	65	65
FAZ II Plus 20	gvz	100	160	200	8.8	6.1	95	85	8.8	6.1	95	95
	gvz	180	270	200	8.8	6.1	95	85	8.8	6.1	95	95
	R-70	100	160	200	4.7	9.4	95	85	4.7	9.4	95	95
	R-70	180	270	200	4.7	9.4	95	85	4.7	9.4	95	95
FAZ II Plus 24	gvz	125	200	270	14.7	9.5	100	100	14.7	9.5	100	135
	R-70	125	200	270	6.9	13.6	100	100	6.9	13.6	100	135

¹⁾ The design values of the cyclic fatigue loading apply for load cycles $> 10^6$ in accordance with design method I acc. to TR061 – for unknown static lower load. If the static lower load is known and / or for lower number of load cycles higher load values are possible. The partial safety factors as regulated in the design standard are considered. As a single anchor counts e.g. an anchor with a spacing $s \geq 3 \times h_{ef}$. Drill hole cleaning acc. to assessment.

²⁾ For higher concrete strength classes up to C50/60 higher permissible loads may be possible. - see assessment. The concrete is assumed to be standard-reinforced.

³⁾ In the case of combinations of tensile loads and shear loads, with reduced or minimum spacing and edge distances (anchor groups) the design must be carried out in accordance with the provisions of the complete assessment.



fischer PRO. The mobile fixing expert.

www.fischer-international.com

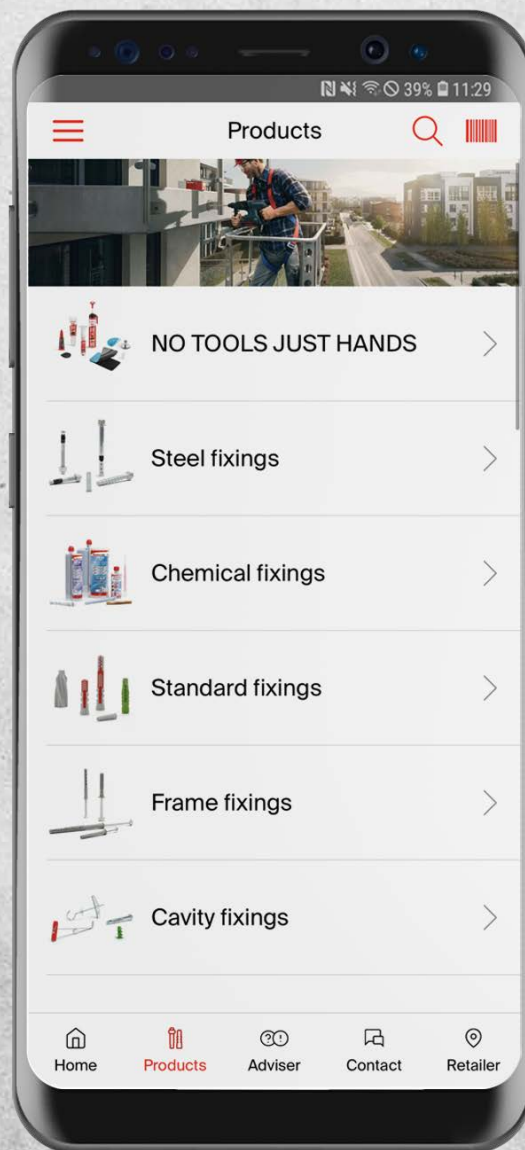

Our 360° service to you.

From software solutions, to training, to personal consulting. As a reliable partner, we are always happy to assist you with words and deeds.



Your advantages:

- Our products range from chemical resin systems to steel anchors through to nylon anchors.
- Competence and innovation through own research, development and production.
- Global presence and active sales service in over 100 countries.
- Qualified technical consulting for economical and compliant fastening solutions. Also on-site at the construction site if requested.
- Training sessions, some with accreditation, at your premises or at the fischer academy.
- Design and construction software for demanding applications.

Design Software fischer FiXperience.

The fischer design Software FiXperience gives you safe and reliable support in measuring your projects whether you are a planner, structural engineer or craftsman. Measuring has never been so simple!



Software and modules for your daily work.

- The modular design program includes engineering software and application modules.
- The software is based on international design standards (EN 1992-4, EC1, EC2, EC3 and EC5), including the national application documents. All common force and measurement units are available.
- Incorrect input will be recognized and the software gives tips to get a correct result. This ensures a safe and reliable design every time.
- The graphical display can easily be rotated through 360°, panned, tilted or zoomed as required.
- The 3D display gives a detailed and realistic image.
- The “live update” feature helps to keep the program up to date ensuring you are always working with the latest version.
- Free download and updates at: www.fischer.de/fixperience-en

Dealer:

www.fischer-international.com



fischer stands for

Fixing Systems
Automotive
fischertechnik
Consulting
Electronic Solutions

fischerwerke GmbH & Co. KG
Klaus-Fischer-Straße 1 · 72178 Waldachtal
Germany
T +49 7443 12-0
www.fischer-international.com · info@fischer.de
